

Excellence in Manufacturing

# UNAFLEX<sup>®</sup> LLC

ISO 9001:2008 CERTIFIED



# METAL HOSE

Fittings and Assemblies



Thermal Products Inc.  
964A Route 146  
Clifton Park, NY 12065  
Ph: (518) 877-0231 Fx: (518) 877-3329  
sales@thermalproducts.com  
www.thermalproducts.com

UNAFLEX® is the nation's foremost manufacturer of expansion joints and flexible connectors. Designs range from rugged spool-type expansion joints constructed out of any elastomer, to exotic alloy multi-ply dual bellows. Our space saving Teflon® Style 112 and 113 offer maximum chemical resistance in a compact connector while our exclusive Combined Technology products create a unique hybrid solution with enhanced capabilities for the most demanding applications. The need for metal hose built to exacting specifications, culminated in our engineering and manufacture of UNAFLEX® Matchless Metal Hose presented in this catalog.

## TABLE OF CONTENTS

Metal Hose Construction .....	3
Matchless Metal Hose 321 .....	4
Matchless Metal Hose 316 .....	5
Matchless Metal Hose Monel*, Metal Hose Terminology .....	6
Standard Fittings Guide.....	7
Installation, Use and Precautions .....	8
Determination of Live Hose Length, Intermittent Offset Motion.....	9
Technical Page with Temperature Correction Chart .....	10-11
Master Flexible Metal Pump Connectors and Serpent Hose .....	12
Bellows Pump Connectors and Exhaust Connectors.....	13
Special Hose Assemblies .....	14
Corrosion Resistance Guide.....	15

UNAFLEX® also produces a complete line of industrial rubber hose including material handling hose as well as chemical and food grade applications. Sheet rubber and matting are also available.

UNAFLEX® manufactures a complete line of annular metal hose in many different sizes, alloys and configurations. Our Matchless metal hose is ideal for absorbing vibration, misalignment, piping expansion or contraction and equipment motion.

Braiding enables use at high pressures and also attenuates vibration. Each annular corrugation is a separate element engineered to impart optimal flexibility for each size of hose that we offer.

## TYPES OF MATCHLESS METAL HOSE AND AVAILABILITY OF OTHER ALLOYS

### **Manufactured from 321 Stainless**

MMH-SS0-Unbraided

MMH-SS1-Single Braid

MMH-SS2-Double Braid

### **Manufactured from Monel®**

MMH-SM0-Unbraided

MMH-SM1-Single Braid

MMH-SM2-Double Braid

### **Manufactured from 316 Stainless**

MMH-SQ0-Unbraided

MMH-SQ1-Single Braid

MMH-SQ2-Double Braid

### **Manufactured from 304 Stainless Steel**

MMH-SN0-Unbraided

MMH-SN1-Single Braid

MMH-SN2-Double Braid

Please contact the factory for other hose alloys that may be required for special service applications. If a hose application requires a less flexible product, UNAFLEX® can supply it in an open pitch configuration.

**Matchless Metal Hose (MMH) Style "S"  
(321 Stainless)**

**Construction Details**

MMH-SSO Unbraided Hose  
MMH-SS1 Single Braided Hose  
MMH-SS2 Double Braided Hose

Type 321 Stainless Steel Butt Welded Tube  
Annular Close Pitch Corrugations  
Type 304 Stainless Steel Braid

Nominal Hose I.D. (in.)	Hose Type	Nominal Hose O.D. (in.)	Max Working Pressure P.S.I.G. @70°	Max. Test Pressure P.S.I.G. @70°	Rated Burst Pressure P.S.I.G. @70°	Constant Flexing (in.)	Static Bend (in.)	Min. Live Length for Normal Vibration (in.)	Approx. Weight Lbs. Per Foot
1/4	MMH-SSO	.48	200	300	-	5	1	4	.12
	MMH-SS1	.54	1500	2250	6000				.21
	MMH-SS2	.60	2250	3375	9000				.30
3/8	MMH-SSO	.66	125	185	-	6	1-1/4	4-1/2	.20
	MMH-SS1	.72	1250	1875	5000				.33
	MMH-SS2	.78	1875	2800	7500				.46
1/2	MMH-SSO	.82	90	135	-	7	1-1/2	5	.22
	MMH-SS1	.88	1050	1570	4200				.35
	MMH-SS2	.94	1575	2355	6250				.48
3/4	MMH-SSO	1.22	75	110	-	8	2	6	.45
	MMH-SS1	1.28	880	1320	3520				.65
	MMH-SS2	1.35	1300	1950	5400				.85
1	MMH-SSO	1.47	55	45	-	9	3	6-1/2	.60
	MMH-SS1	1.52	615	925	2460				.80
	MMH-SS2	1.60	900	1350	3600				1.0
1-1/4	MMH-SSO	1.83	30	45	-	10	4	7	.70
	MMH-SS1	1.89	570	850	2275				1.0
	MMH-SS2	1.95	850	1275	3400				1.3
1-1/2	MMH-SSO	2.08	25	35	-	11	5	8	1.0
	MMH-SS1	2.14	425	637	1700				1.4
	MMH-SS2	2.20	637	955	2550				1.8
2	MMH-SSO	2.61	15	22	-	13	6	9	1.2
	MMH-SS1	2.69	470	710	1880				1.8
	MMH-SS2	2.77	695	1045	2780				2.4
2-1/2	MMH-SSO	3.34	12	18	-	15	7	10	1.3
	MMH-SS1	3.42	450	675	1800				2.1
	MMH-SS2	3.50	675	1012	2700				2.9
3	MMH-SSO	3.88	10	15	-	18	9	11	1.7
	MMH-SS1	3.99	285	428	1140				2.4
	MMH-SS2	4.11	400	600	1600				3.1
4	MMH-SSO	4.80	8	12	-	22	11	12	1.9
	MMH-SS1	4.90	250	375	1000				3.5
	MMH-SS2	5.00	325	487	1300				4.1
5	MMH-SSO	5.80	8	12	-	28	14	13	3.9
	MMH-SS1	6.02	225	338	900				5.4
	MMH-SS2	6.24	335	480	1330				6.9
6	MMH-SSO	7.00	5	7	-	34	16	14	4.2
	MMH-SS1	7.14	200	300	800				6.1
8	MMH-SSO	9.00	3	5	-	42	20	16	5.4
	MMH-SS1	9.26	200	300	800				9.4
10	MMH-SSO	11.30	3	4.5	-	50	24	18	6.9
	MMH-SS1	11.55	150	225	600				13.3
12	MMH-SSO	13.25	2	3	-	58	28	20	8.6
	MMH-SS1	13.50	150	225	600				15.0
14	MMH-SSO	14.40	2	3	-	66	36	22	11.9
	MMH-SS1	14.65	140	210	560				18.0
16	MMH-SSO	16.40	2	3	-	74	40	26	16.0
	MMH-SS1	16.65	100	150	400				22.1
18	MMH-SSO	18.75	2	3	-	82	46	28	18.0
	MMH-SS1	19.00	80	120	320				24.4
20	MMH-SSO	20.75	1	1.5	-	90	52	30	20.1
	MMH-SS1	21.00	70	105	280				26.7
22	MMH-SSO	22.75	1	1.5	-	98	56	32	22.2
	MMH-SS1	23.00	50	75	200				29.0
24	MMH-SSO	24.75	1	1.5	-	104	60	36	24.3
	MMH-SS1	25.00	40	60	160				31.0
30	MMH-SSO	30.75	1	1.5	-	128	80	48	30.5
	MMH-SS1	31.00	22	33	88				40.1

**Matchless Metal Hose (MMH) Style "Q"  
(316 Stainless)**

**Construction Details**

MMH-SQO Unbraided Hose  
MMH-SQ1 Single Braided Hose  
MMH-SQ2 Double Braided Hose

Type 316 Stainless Steel Butt Welded Tube  
Annular Close Pitch Corrugations  
Type 304 Stainless Steel Braid

Nominal Hose I.D. (in.)	Hose Type	Nominal Hose O.D. (in.)	Max Working Pressure P.S.I.G. @70°	Max. Test Pressure P.S.I.G. @70°	Rated Burst Pressure P.S.I.G. @70°	Constant Flexing (in.)	Static Bend (in.)	Min. Live Length for Normal Vibration (in.)	Approx. Weight Lbs. Per Foot
1/4	MMH-SQO	.50	200	300	-	5	1	4	.12
	MMH-SQ1	.56	1425	2137	5700				.21
	MMH-SQ2	.64	2137	3206	8550				.30
3/8	MMH-SQO	.66	100	150	-	6	1-1/4	4-1/2	.20
	MMH-SQ1	.72	1187	1781	4750				.33
	MMH-SQ2	.78	1781	2660	7125				.46
1/2	MMH-SQO	.83	90	135	-	7	1-1/2	5	.22
	MMH-SQ1	.89	997	1491	3990				.35
	MMH-SQ2	.97	1496	2237	5937				.48
3/4	MMH-SQO	1.22	75	110	-	8	2	6	.45
	MMH-SQ1	1.28	836	1254	3344				.65
	MMH-SQ2	1.35	1235	1852	5130				.85
1	MMH-SQO	1.47	55	45	-	9	3	6-1/2	.60
	MMH-SQ1	1.52	584	878	2337				.80
	MMH-SQ2	1.60	855	1282	3420				1.0
1-1/4	MMH-SQO	1.83	30	45	-	10	4	7	.70
	MMH-SQ1	1.89	541	807	2161				1.0
	MMH-SQ2	1.95	807	1211	2330				1.3
1-1/2	MMH-SQO	2.08	25	35	-	11	5	8	1.0
	MMH-SQ1	2.14	403	605	1615				1.4
	MMH-SQ2	2.20	605	907	2422				1.8
2	MMH-SQO	2.61	15	22	-	13	6	9	1.2
	MMH-SQ1	2.69	446	674	1786				1.8
	MMH-SQ2	2.77	660	992	2641				2.4
2-1/2	MMH-SQO	3.34	12	18	-	15	7	10	1.3
	MMH-SQ1	3.42	427	641	1710				2.1
	MMH-SQ2	3.50	641	961	2565				2.9
3	MMH-SQO	3.88	10	15	-	18	9	11	1.7
	MMH-SQ1	3.99	270	406	1083				2.4
	MMH-SQ2	4.11	380	570	1520				3.1
4	MMH-SQO	4.80	8	12	-	22	11	12	1.9
	MMH-SQ1	4.90	237	356	950				3.5
	MMH-SQ2	5.00	308	462	1235				4.1
5	MMH-SQO	5.80	8	12	-	28	14	13	3.9
	MMH-SQ1	6.02	213	321	855				5.4
	MMH-SQ2	6.24	318	456	1263				6.9
6	MMH-SQO	7.00	5	7	-	34	16	14	4.2
	MMH-SQ1	7.14	190	285	760				6.1
8	MMH-SQO	9.00	3	5	-	42	20	16	5.4
	MMH-SQ1	9.26	190	285	760				9.4
10	MMH-SQO	11.30	3	4.5	-	50	24	18	6.9
	MMH-SQ1	11.55	142	213	570				13.3
12	MMH-SQO	13.25	2	3	-	58	28	20	8.6
	MMH-SQ1	13.50	142	213	570				15.0
14	MMH-SQO	14.40	2	3	-	66	36	22	11.9
	MMH-SQ1	14.65	133	199	532				18.0
16	MMH-SQO	16.40	2	3	-	74	40	26	16.0
	MMH-SQ1	16.65	95	142	380				22.1
18	MMH-SQO	18.75	2	3	-	82	46	28	18.0
	MMH-SQ1	19.00	76	114	304				24.4
20	MMH-SQO	20.75	1	1.5	-	90	52	30	20.1
	MMH-SQ1	21.00	66	99	266				26.7
22	MMH-SQO	22.75	1	1.5	-	98	56	32	22.2
	MMH-SQ1	23.00	47	71	190				29.0
24	MMH-SQO	24.75	1	1.5	-	104	60	36	24.3
	MMH-SQ1	25.00	38	57	152				31.0
30	MMH-SQO	30.75	1	1.5	-	128	80	48	30.5
	MMH-SQ1	31.00	20	31	83				40.1



# MONEL<sup>®</sup>

Matchless Metal Hose (MMH) Style "M" (Monel<sup>®</sup>)

## Construction Details

MMH-SM0 Unbraided Hose

Monel<sup>®</sup> alloy butt welded Tube

MMH-SM1 Single Braided Hose

Type 304 Stainless Steel Braid

PRESSURE DATA						BEND RADIUS			
Nominal Hose I.D. (in.)	Hose Type	Nominal Hose O.D. (in.)	Max Working Pressure P.S.I.G. @70°	Max. Test Pressure P.S.I.G. @70°	Rated Burst Pressure P.S.I.G. @70°	Constant Flexing (in.)	Static Bend (in.)	Min. Live Length for Normal Vibration (in.)	Approx. Weight Lbs. Per Foot
1/4	MMH-SM0 MMH-SM1	1.5 1.56	60 680	90 1020	2720	9	3	7	.85 1.12
1-1/4	MMH-SM0 MMH-SM1	1.82 1.88	35 500	52 750	2000	10	3-1/2	8	1.15 1.53
1-1/2	MMH-SM0 MMH-SM1	2.09 2.17	25 375	38 560	1590	11	4	9	1.60 2.05
2	MMH-SM0 MMH-SM1	2.16 2.70	18 300	27 450	1200	12	5	10	2.00 2.63
2-1/2	MMH-SM0 MMH-SM1	3.30 3.38	12 230	18 360	920	14	7	11	2.5 2.23
3	MMH-SM0 MMH-SM1	3.80 3.90	10 225	15 338	900	18	8	12	2.6 2.25
4	MMH-SM0 MMH-SM1	4.90 5.00	8 175	12 262	700	22	11	13	3.5 4.65

## METAL HOSE TERMINOLOGY

**Annular**-A Hose profile that is designed so each convolution is a separate circle or ring.

**Braid**-Woven wire cover placed over hose which prevents elongation of the hose and permits higher working pressure.

**Close Pitch**-More corrugations per foot which renders the longest fatigue life and minimum bend radius.

**Constant Flexing Bend Radius**-The minimum radius to which a hose can be repeatedly bent and render satisfactory flexure life.

**Constant Motion**-Motion that occurs on a regular cyclic basis at a constant travel.

**Fittings**-Parts attached to the ends of metal hose so that it can be connected other components such as flanges, unions, nipples, etc.

**Flow Velocity**-When the flow velocity exceeds 75 ft./second liquid, 150 ft./second gas in braided hose, a flexible metal liner should be used.

**Intermittent Motion**-Motion that occurs on a regular or irregular cyclic basis.

**Maximum Test Pressure**-Maximum pressure hose assembly should be subject to for testing purposes. Based on 150% of the Maximum Working Pressure.

**Media**-Conveyant in a hose assembly such as gases, liquids, etc.

**Operating Conditions**-Temperature, Pressure, Media, Motion and Application involved.

**Random Motion**-Uncontrolled motion that occurs usually from manual handling of hose.

**Rated Burst Pressure**-Pressure at which hose can be expected to fail. Braid will normally fail before core burst.

**Safety Factor**-Difference between working pressure and rated burst pressure.

**Shock or pulsating Pressure**-Shock, pulsating or surge pressure can cause premature failure of hose.

**Static Bend**-Minimum center bend radius to which flexible metal hose may be bent for installation.

**Vibration**-High frequency, low amplitude

**Working Temperature**-Temperature to which hose will be subjected during operation

**MALE NIPPLE (MN)**

Size	"A"	"B"
1/4	1-1/2	2
3/8	1-1/2	2
1/2	1-1/2	2
3/4	1-1/2	2
1	2	2-1/2
1-1/4	2	2-1/2
1-1/2	2	2-1/2
2	2-1/2	3-1/2
2-1/2	3	4
3	3	4
4	3	4

**WELD NIPPLE (W)**

Size	"A"	"B"
3/4	2-1/2	3
1	2-1/2	3
1-1/4	2-1/2	3
1-1/2	3	4
2	3	4
2-1/2	3	4
3	4	5
4	4	5
5	4	5
6	6	7
8	6	7

**HEX MALE (HM)**

Size	"A"	"B"
1/4	1	1-1/2
3/8	1	1-1/2
1/2	1	1-1/2
3/4	1-1/4	1-3/4
1	1-1/2	2
1-1/4	2	2-1/2
1-1/2	2-1/4	2-3/4

**FEMALE COUPLING (C)**

Size	"A"	"B"
1/4	11/16	1-1/16
3/8	3/4	1-1/8
1/2	3/4	1-1/8
3/4	3/4	1-1/8
1	1	1-3/4
1-1/4	1	1-3/4
1-1/2	1	1-3/4
2	1-1/4	2
2-1/2	1-7/16	2-7/16
3	1-5/8	2-5/8
4	1-7/8	2-7/8

**MALE UNION (MU)**

Size	"A"	"B"
1/4	2-1/4	2-5/8
3/8	2-1/2	3
1/2	2-3/4	3-1/4
3/4	3-1/8	3-7/8
1	3-3/8	4-3/8
1-1/4	3-3/4	4-3/4
1-1/2	4	5-1/4

**FEMALE UNION (FU)**

Size	"A"	"B"
1/4	1-7/16	2-1/16
3/8	1-5/8	2-1/8
1/2	1-13/16	2-3/16
3/4	2	2-1/2
1	3-3/16	3-3/16
1-1/4	3-7/16	3-7/16
1-1/2	3-5/8	3-5/8
2	4	4
2-1/2	4-1/4	4-1/4
3	4-1/2	4-1/2

**FIXED FLANGE (F)**

Size	"A"	"B"
1	2	2-5/8
1-1/4	2	2-3/4
1-1/2	2	2-3/4
2	2-1/2	3-3/8
2-1/2	2-1/2	3-3/8
3	2-1/2	3-3/8
4	3	3-3/4
5	3	3-3/4
6	3-1/2	4-1/2
8	4	5

**FLOATING FLANGE (V)**

Size	"A"	"B"
1	2	2-5/8
1-1/4	2	2-3/4
1-1/2	2	2-3/4
2	2-1/2	3-1/2
2-1/2	2-1/2	3-1/2
3	2-1/2	3-1/2
4	3	3-3/4
5	3	3-3/4
6	3-1/2	4-1/2
8	4	5

The variety of fittings available for weld attachment to metal hose is nearly unlimited. If the required end fitting is not shown above, please specify what your system requires. Our standard fittings are carbon steel, but stainless steel is readily available. Simply add the prefix "S" to any of the designations for 304 stainless steel.

**Refer to installation, precautions, use and technical pages**

## INSTALLATION, USE AND PRECAUTIONS

UNAFLEX® Matchless Metal Hose will render maximum service life when properly installed. The following precautions should be observed when installing flexible metal hose.

### AVOID TORQUE

Torque or twisting is harmful to hose and substantially reduces service life. Installation torque can be avoided by using a floating flange or union at one end of an assembly in place of a rigid connection. Always install hose so that flexing takes place in one plane.

### AVOID OVERBENDING

If metal hose is bent below the minimum recommended bend radius, fatigue and premature failure can result. This bending often occurs at end connections and can be avoided by installing an interlock guard or elbow.

### AVOID IMPROPER HANDLING

Always lift hose—do not drag. Do not permit hose to be stored in an area where it is subject to spills, corrosive sprays, etc.

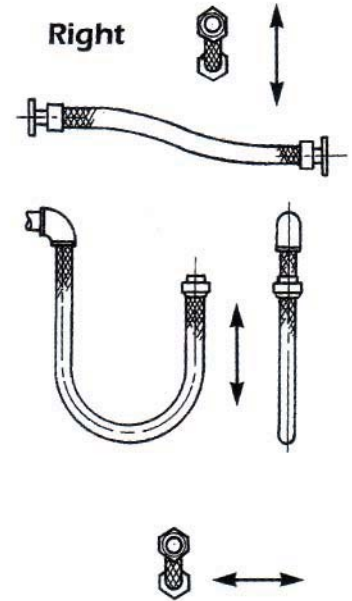

**Wrong**

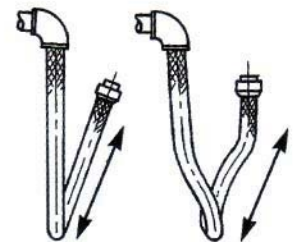

**Right**

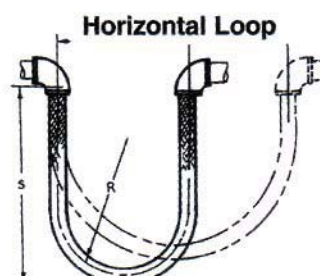
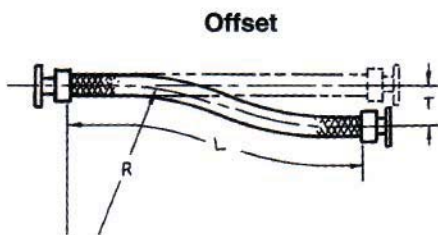
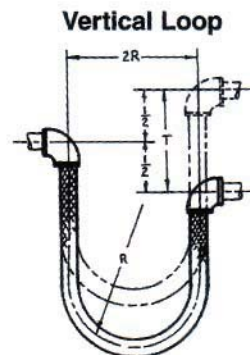
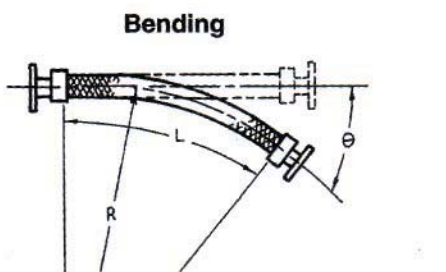
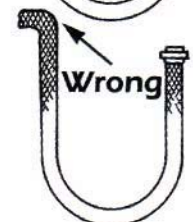



## INTERMITTENT OFFSET MOTION

Note: The values shown in bold are applicable to non-moving bends only. For intermittent flexing, the offset motion should not exceed 25% of the center line bend radius.

Center Line Radius in.=(R)	24-1/4 Maximum Distance From Centerline=(T)													
	1/8"	1/4"	3/8"	1/2"	3/4"	1"	1-1/2"	2"	3"	4"	5"	6"	8"	10"
2	1-1/4	1-3/4	2-1/4	2-1/2	3-1/4	3-3/4	4-1/2	5-1/4	6-3/4	8	9-1/4	10-1/2	11-3/4	15
4	1-3/4	2-1/2	3	3-1/2	4-1/4	5	6-1/4	7-1/4	9	10-3/4	12	13-1/2	16	18-1/2
6	2-1/4	3-1/4	3-3/4	4-1/4	5-1/4	6-1/4	7-1/2	8-1/4	10-3/4	12-3/4	14-1/4	16	19	21-1/2
8	2-1/2	3-1/2	4-1/4	5	6	7	8-3/4	10	12-1/2	14-1/2	16-1/4	18	20-1/2	24-1/4
10	2-3/4	4	4-3/4	5-1/2	6-3/4	8	9-3/4	11-1/4	13-3/4	16	18	20	23-1/2	26-1/2
12	3	4-1/4	5-1/4	6	7-1/2	8-1/2	10-1/2	12-1/4	15	17-1/2	19-1/2	21-1/2	25-1/2	28-3/4
14	3-1/4	4-3/4	5-3/4	6-1/2	8	9-1/4	11-1/4	13-1/4	16-1/4	18-3/4	21	23-1/2	27-1/4	30-3/4
16	3-1/2	5	6	7	8-1/2	10	12-1/4	14	17-1/4	20	22-1/2	25	29	32-3/4
18	3-3/4	5-1/4	6-1/2	7-1/2	9	10-1/2	13	15	18-1/4	21-1/4	24	26	30-1/2	34
20	4	5-1/2	6-3/4	7-3/4	9-1/2	11	13-1/2	16-3/4	19-1/4	22-1/2	25	27-1/2	32-1/4	36-1/4
25	4-1/2	6-1/4	7-1/2	8-3/4	10-3/4	12-1/4	15	17-1/2	21-1/2	25	28	30-1/2	35-3/4	40
30	4-3/4	6-3/4	8-1/4	9-1/2	11-3/4	13-1/2	16-1/2	19	23-1/2	27-1/4	30-1/2	33-1/2	39	43-3/4
35	5-1/4	7-1/4	9	10-1/4	12-1/2	14-1/2	18	20-3/4	26-1/4	29-1/2	32-3/4	36	42	47
40	5-1/2	7-3/4	9-1/2	11	13-1/2	15-1/2	19	22	27	31-1/4	35	38-1/2	44-3/4	50
45	6	8-1/4	10	11-3/4	14-1/4	16-1/2	20-3/4	23-1/2	28-1/2	33-1/4	37	41	47-1/2	53
50	6-1/4	8-3/4	10-3/4	12-1/4	15	17-1/2	21-1/2	24-3/4	30	35	39	43	50	56
60	6-3/4	9-1/2	11-3/4	13-1/2	16-1/2	19	23-1/4	27	33	38-1/4	43	47	54-1/2	61
70	7-1/4	10-1/4	12-3/4	14-3/4	17-3/4	20-1/2	25-1/4	29	35-1/2	41-1/2	46	51	58-3/4	66-1/4
80	7-3/4	11	13-1/2	15-1/2	19	22	27	31	38	44	49-1/2	54	62-3/4	70
90	8-1/4	11-3/4	14-1/4	16-1/2	20-1/4	23-1/2	28-1/2	33	40-1/2	46-3/4	52	57-1/4	66-1/4	74-1/4
100	8-3/4	12-1/4	15	17-1/2	21-1/4	24-1/2	30-1/2	35	42-1/2	49-1/4	55	60-1/2	69-3/4	78-1/4
110	9-1/4	13	15-3/4	18-1/4	22-1/2	25-3/4	31-3/4	36-1/2	44-3/4	51-1/2	58	63-1/4	73-1/4	82
120	9-1/2	13-1/2	16-1/2	19	23-1/4	27	33	38-1/4	46-3/4	54	60-1/2	66	76-1/2	85-1/2
130	10	14	17-1/4	20	24-1/4	28	34-3/4	39-3/4	48-1/2	56	62-3/4	68-3/4	79-1/2	89

### ASSEMBLY LENGTH/O.A.L.

After the hose is selected for the application, the live length and overall length of the assembly must be determined. After the live length has been determined, the overall length (O.A.L.) is calculated by adding the dimensions for the selected end fitting.

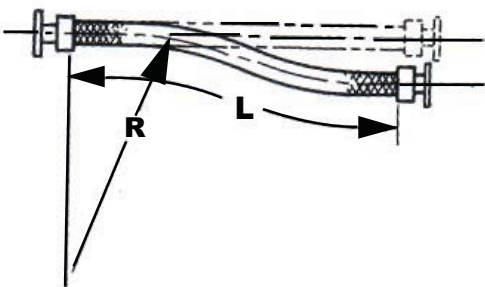

Live Length=(L)

### PRESSURE DROP FOR WATER

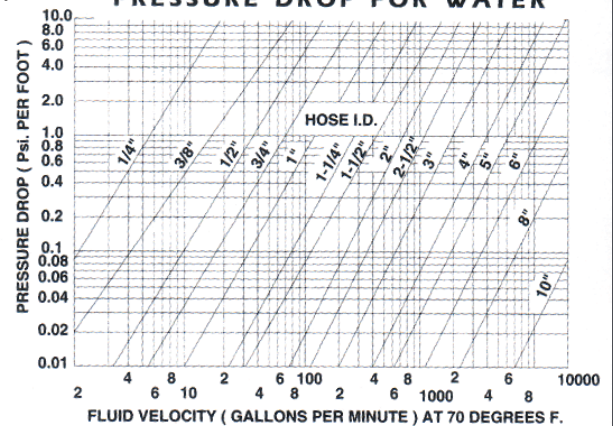

## TEMPERATURE CORRECTION FACTORS FOR ELEVATED TEMPERATURE

As the service temperature increases, the maximum pressure a hose assembly can withstand decreases. The material from which the hose is made and the method of fitting attachment (mechanical, soldered, welded, silver brazed) determine the maximum pressure at which an assembly can be used. By using the factors given in the chart below, the approximate safe working pressure at elevated temperatures can be calculated for assemblies with welded or mechanically attached fittings.

**Example:**

Determine if 3/4" annular stainless hose with welded fittings is satisfactory for the given operating conditions.

**Given:**

Maximum operating temperature is 600 Deg. F. Maximum operating pressure is 300PSIG.

**Computation:**

From the Series MMH-SSI Hose Type-nominal rated burst pressure is 3/4" MMH series with welded fittings is 3520 PSIG. From temperature Correction Factors Chart factor for stainless T321 at 600 Deg F is 0.74.

**Results:**

Since the maximum operating pressure for MMH-551 Hose Type at 600 Deg F is 651 PSIG. The hose will meet the required operating conditions outlined above.

TEMPERATURE CORRECTION FACTORS			
Temp (Deg F.)	T321 / T3161	T304	Carbon Steel
70F	1	1	1
105F	0.97	0.96	0.99
200F	0.94	0.92	0.97
250F	0.92	0.91	0.96
300F	0.88	0.86	0.93
350F	0.86	0.85	0.91
400F	0.83	0.82	0.87
450F	0.81	0.8	0.86
500F	0.78	0.77	0.81
600F	0.74	0.73	0.74
700F	0.7	0.69	0.66
800F	0.66	0.64	0.52
900F	0.62		
1000F	0.6		
1100F	0.58		
1200F	0.55		
1300F	0.5		
1400F	0.44		
1500F	0.4		

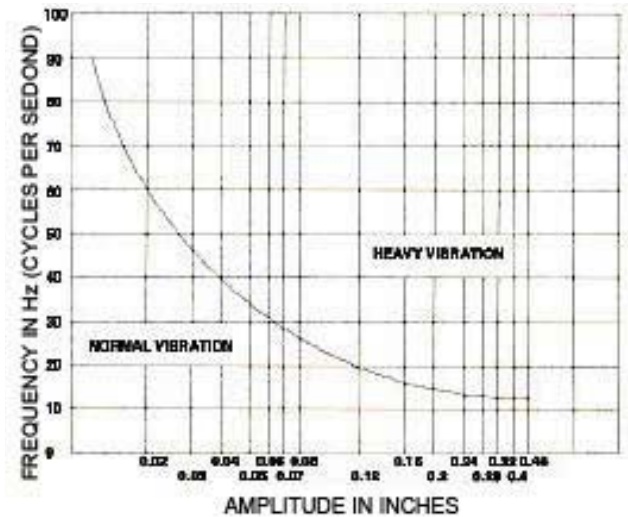

Pressure PSI Gauge Vacuum Inches of HG

<b>THERMAL EXPANSION OF PIPE (INCHES PER 100 FT.)</b>					
	<b>Temp. Degrees F.</b>	<b>Carbon Steel</b>	<b>4-6% Cr Alloy Steel</b>	<b>18 Cr-8 Ni Stainless Steel</b>	<b>Monel® Alloy 400</b>
Saturated Steam, Vacuum In. Hg Below 212° F, Pressure PSI Gauge Above 212° F	-200	-1.282	-1.250	-2.030	-1.64
	-160	-1.066	-1.030	-1.670	-1.32
	-100	-0.698	-0.7000	-1.090	-0.82
	-60	-0.428	-0.430	-0.670	-0.49
	-40	-0.288	-0.290	-0.450	-0.32
	-20	-0.145	-0.145	-0.225	-0.17
	0	0	0	0	0
	20	0.148	0.140	0.223	0.197
	32	0.230	0.234	0.356	0.315
		40	0.285	0.280	0.446
-	60	0.448	0.430	0.669	0.591
29.39	80	0.580	0.600	0.892	0.790
28.89					
27.99	100	0.753	0.750	1.115	0.985
26.48	120	0.910	0.900	1.338	1.18
24.04	140	1.064	1.050	1.545	1.38
	160	1.223	1.220	1.784	1.58
20.27	180	1.383	1.370	2.000	1.77
14.63	200	1.546	1.520	2.230	1.97
6.45					
8	212	1.643	1.600	2.361	2.09
10.03	240	1.875	1.825	2.680	2.36
20.7	260	2.038	2.000	2.920	2.56
	300	2.374	2.320	3.375	2.95
52.3	340	2.717	2.625	3.840	3.35
103.3	380	3.066	2.980	4.346	3.74
180.9					
293.7	420	3.421	3.300	4.800	4.14
451.3	460	3.784	3.650	5.335	4.53
664.3	500	4.151	4.000	5.800	4.92
	540	4.525	4.350	6.320	5.32
945.3	580	4.906	4.740	6.835	5.71
1308	620	5.292	5.110	7.370	6.11
1768					
	660	5.686	5.470	7.900	6.50
2346	700	6.084	5.850	8.425	6.89
3080	740	6.490	6.220	8.932	7.29
	800	7.105	6.800	9.750	7.88
	840	7.517	7.200	10.270	8.28
	900	8.168	7.770	11.075	8.86
	960	8.830	8.360	11.900	9.46
	1000	9.276	8.760	12.432	9.85

## UNAFLEX<sup>®</sup> MASTER FLEXIBLE METAL PUMP CONNECTORS

UNAFLEX<sup>®</sup> “Master” Metal Pump Connectors are designed with a flexible core of corrugated-type 321 stainless steel tubing under the braid. Flat face flanges are standard: however other types (150# R.F., 300#, stainless, millimetric, male nipples) are available. A wire braid is used over the flexible core on most designs to provide strength for the rated operating pressure. Braid for stainless steel core is either type 321 or 304 stainless steel.



### FLANGED METAL PUMP CONNECTOR SPECIFICATIONS

Part Number	Flange IPS and Nominal Hose ID (in.)	Overall Length	Max W.P. at Room Temp. (psi)	Approx. Wt. (lbs.) Per Unit
SFPC 025	2-1/2	9"	300	16
SFPC 03	3	9"	250	19
SFPC 04	4	9"	200	23
SFPC 05	5	11"	200	32
SFPC 06	6	11"	200	40
SFPC 08	8	12"	200	62
SFPC 10	10	13"	150	101
SFPC 12	12	14"	125	153
SFPC 14	14	14"	100	200

### THREADED MALE PUMP CONNECTOR SPECIFICATIONS

Part Number	Flange IPS and Nominal Hose ID (in.)	Overall Length	Max W.P. at Room Temp. (psi)	Approx. Wt. (lbs.) Per Unit
SMPC 0.5	1/2	6-1/2"	950	1/2
SMPC 0.75	3/4	7"	700	1
SMPC 01	1	8"	550	1
SMPC 0.125	1-1/4	8-1/2"	420	1-1/2
SMPC 0.15	1-1/2	9"	380	2
SMPC 02	2	10-1/2"	300	2-1/2
SMPC 0.25	2-1/2	12"	300	2-1/2
SMPC 03	3	14"	250	4
SMPC 04	4	16"	200	4-1/2

## SERPENT RUBBER COVERED METAL HOSE

There are those applications where a corrugated inner liner of stainless steel, bronze or Monel<sup>®</sup> are the answer to your chemical transfer problems. When this is the case, you do not have to sacrifice the handling characteristics, safety and durability of a rubber hose. UNAFLEX<sup>®</sup> combines the two through a proprietary vulcanization process which adheres the scuff and abrasion resistant cover directly to the wire reinforced metal hose.





## SERIES 5000 BPC BELLOWS PUMP CONNECTOR ASSEMBLIES

METAL BELLOWS PUMP CONNECTOR DIMENSIONS			
Dash Number	Nominal ID (in.)	Overall Length	Flange Thickness (in.)
-032	2	3-1/2	5/8
-040	2-1/2	3-1/2	5/8
-048	3	4	5/8
-056	3-1/2	4	5/8
-064	4	4-1/2	5/8
-080	5	4-1/2	5/8
-096	6	5	5/8
-128	8	5	5/8
-160	10	6	3/4
-192	12	6	3/4
-224	14	8	1
-256	16	8	1

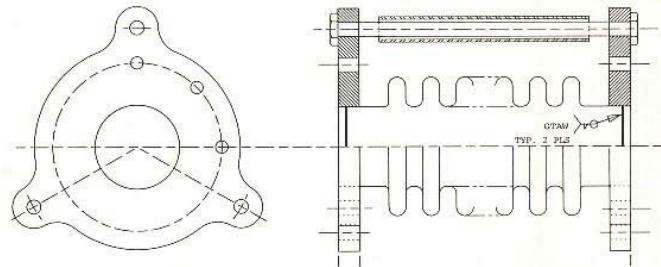

### Standard Operating Specifications

Max Operating Pressure 150 PSI  
Max. Operating Temp. 800° F

### Movement

Axial Comp (2" to 8" Nom.) 1/2"  
Axial Comp (10" to 16" Nom.) 3/4"  
Axial Ext. (All sizes) 1/4"  
Lateral Offset (All sizes) 1/8"

Flanges to mate with ANSI B16.5 150# Flange Drilling. If flow velocity exceeds 25 F.P.S. a liner must be added.

**Ordering Code**  
Nom. Size, Dash Number, Liner  
Example:  
3" BPC-048L  
Standard end configuration-44 (welded)

## BELLOWS EXHAUST CONNECTORS

UNAFLEX® Tube-Flex Series 7000 Stainless Steel Engine exhaust Expansion Joints are manufactured from a butt welded stainless steel tube. This tubular body is formed into corrugations creating a bellows providing a highly flexible and durable connection for the extremes of exhausting engine gases.

### END CONNECTIONS

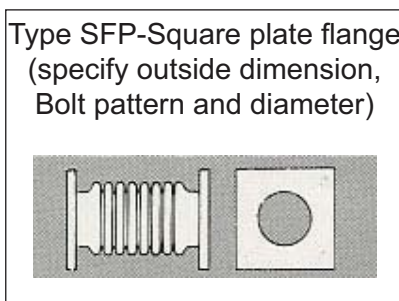
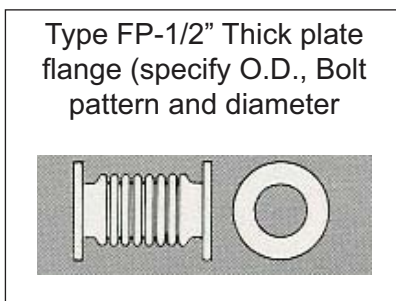
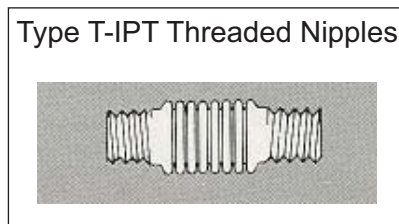
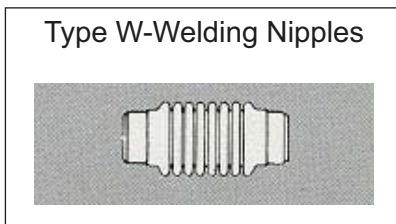

Part Number	Pipe Size	Max. Operating Pressure @ 70° F	Standard Length (in.)
7001	1"	40	18
7101	1-1/4"	24	18
7201	1-1/2"	20	18
7002	2"	15	18
7003	3"	8	18
7004	4"	5	18
7005	5"	3	18
7006	6"	3	18
7008	8"	3	18
7010	10"	2	18
7012	12"	2	18



## SPECIAL HOSE ASSEMBLIES

For many years UNAFLEX® has combined technologies of metal hose with expansion joints into composite assemblies to perform in special applications. When an unusual or difficult problem must be solved, UNAFLEX® Engineering can create a solution. Some examples are shown below.

Large diameter metal hose are frequently the only practical transfer hose for various chemicals, particularly if elevated temperatures are included.

**Need even more flexibility?** UNAFLEX® Engineering can vary core widths, height and metal gauge to provide a custom hose based on your design requirements. Consult factory for details.

### JACKETED ASSEMBLY

When conveyants must be maintained at a specified temperature, steam jacketing is used frequently, often in lieu of electric tracing.



### GUARDED ASSEMBLY

Use of an external flexible armor protects metal hose from abuse due to rough handling, abrasion and bending below its limits. Often a rubber cover can accomplish this as well as armor if temperatures will permit.



### LINED ASSEMBLY

If high conveyant velocities are required, use of an internal flexible metal liner will prevent damage and reduce abrasion problems.



## CORROSION RESISTANCE GUIDE

Acetic Acid	70°	A	A	B	Chromic Acid (10%)	Boil	C	B	B	Paraffin	Hot	A	A	A
Acetic Anhydride	Boil	A	A	B	Cider	70°	A	A	A	Phosph. Acid (20%)	Boil	C	B	B
Acetone	Boil	A	A	A	Citric Acid (15%)	Boil	B	A	B	Potass. Carbonate	Hot	A	A	A
Acetylene	70°	A	A	A	Coffee	Boil	A	A	A	Potass. Chlor. (5%)	Boil	B	B	B
Alcohols	Boil	B	A	A	Copper Chloride (5%)	70°	C	C	A	Potas. Chrom. (25%)	Boil	A	A	B
Aluminum Chloride	70°	C	C	A	Copper Nitrate	Hot	A	A	C	Potas. Cyanide	70°	A	A	A
Aluminum Hydrox.	70°	A	A	B	Copper Sulfate	Boil	A	A	B	Potas. Hydrox. (50%)	Boil	B	A	A
Aluminum Sulfate	Boil	B	A	B	Corn Oil	70°	A	A	A	Potas. Sulfate (5%)	Hot	B	A	B
Ammonia-Dry	Hot	A	A	A	Cottonseed Oil	70°	A	A	A	Propane	70°	A	A	A
Ammonia-Moist	Boil	A	A	C	Creosote	Hot	A	A	A	Rosin	Molten	A	A	A
Ammonium Hydrox.	70°	A	A	A	Crude Oil	Hot	B	A	A	Sea Water	70°	B	B	B
Ammonium Chlor.	Boil	B	A	A	Ethers	70°	A	A	A	Sewage	70°	A	A	A
Ammonium Nitrate	70°	A	A	C	Ethyl Acetate (conct)	70°	A	A	B	Soap Solutions	70°	A	A	A
Ammonium Sulfate	Boil	B	A	B	Ethyl Chloride	70°	A	A	B	Sodium Bicarb. (5%)	150°	A	A	A
Amyl Ace. (conct)	70°	A	A	A	Ethylene Glycol	70°	A	A	A	Sodium Bisulfite	70°	A	A	B
Amyl Alcohol	70°	A	A	A	Ferric Chloride	70°	C	C	B	Sodium Carb. (50%)	Boil	A	A	A
Aniline (conct)	70°	A	A	A	Ferric Sulfate (10%)	Boil	B	A	C	Sodium Chlor. (5%)	150°	C	B	B
Aniline Hydrochlor.	70°	C	C	A	Ferrous Sulfate	Boil	B	A	B	Sodium Cyanide	70°	A	A	B
Asphalt	Hot	A	A	A	Formaldehyde (40%)	70°	B	B	A	Sodium Hydroxide	Boil	A	A	A
Atmosphere, Indust.	70°	A	A	A	Formic Acid (50%)	50°	B	A	B	Sodium Hyp. (5%)	70°	C	B	B
Barium Carbonate	70°	A	A	B	Freon	70°	A	A	A	Sodium Nitrate	70°	A	A	A
Barium Chloride	Hot	B	A	A	Fruit Juices	70°	A	A	A	Sodium Perox. (10%)	150°	A	A	B
Barium Hydroxide	Hot	A	A	B	Furfural	70°	A	A	A	Sodium Phosphate	70°	A	A	A
Barium Sulfate	70°	A	A	B	Gasoline	70°	A	A	A	Sodium Sulf. (10%)	150°	B	A	A
Barium Sulfide	70°	A	A	C	Gelatine	70°	A	A	A	Sodium Thiosulfate	70°	A	A	A
Beer	70°	A	A	A	Glue (Acid Solution)	70°	B	A	A	Steam	200°	A	A	A
Benzine	Hot	A	A	A	Glycerine	70°	A	A	A	Stearic Acid	70°	B	A	B
Benzoic Acid	70°	A	A	B	Hydrobromic Acid	70°	C	C	C	Sugar Solutions	70°	A	A	A
Benzol	Hot	A	A	A	Hydrochloric Acid	70°	C	C	B	Sulfur, Dry	350°	A	A	A
Black Liquor	Hot	B	B	A	Hydrocyanic Acid	70°	A	A	B	Sulfur, Molten	200°	C	B	B
Bleaching Pow., wet	70°	C	C	B	Hydrofluoric Acid	70°	C	C	B	Sulfur Chloride, Dry	Hot	C	C	A
Borax (5%)	Hot	A	A	A	Hydrogen Peroxide	70°	A	A	B	Sulfur Dioxide, Dry	70°	A	A	B
Boric Acid	Boil	A	A	B	Hydrogen Sulfide, Dry	70°	A	A	A	Sulfur Dioxide, Mo.	70°	C	B	C
Bromine, Dry	70°	C	C	A	Hydrogen Sulfide, Mo.	70°	B	A	B	Sulfur Trioxide, Dry	70°	A	A	A
Bromine, Moist	70°	C	C	B	Kerosene	70°	A	A	A	Sulfur. Ac. (95-100%)	70°	A	A	B
Butate	70°	A	A	A	Lacquers	70°	A	A	A	Sulfur. Ac. (80-95%)	70°	B	B	B
Buttermilk	70°	A	A	A	Lacquer Solvents	70°	A	A	A	Sulfur Ac. (40-80%)	Boil	C	C	C
Butyl Alcohol	70°	A	A	A	Lactic Acid (5%)		B	A	B	Sulfur Ac. (40%)	300°	C	C	C
Butyric Acid (5%)	Boil	A	A	B	Lime	70°	A	A	A	Tannic Acid	70°	A	A	B
Calcium Chloride	70°	B	A	B	Lime-Sulfur	70°	B	B	B	Tar	70°	A	A	A
Calcium Hydr. (20%)	Boil	A	A	B	Linseed Oil	70°	A	A	A	Tartaric Acid (10%)	70°	B	A	B
Calcium Hyp. (20%)	70°	C	B	B	Magnesium Chl. (5%)	Hot	C	B	B	Toluene	70°	A	A	A
Cane Sugar Syrups	Hot	A	A	A	Magnesium Sulfate	Hot	B	A	A	Trichloroacetic Acid	70°	C	C	B
Carbolic Acid (Phe.)	Boil	A	A	B	Mercury	70°	A	A	B	Trichlorethylene, Dry	70°	A	A	A
Carbon Dioxide, Dry	Hot	A	A	A	Mercury Salts	70°	C	C	A	Trichlorethylene, Mo.	70°	C	B	B
Carbon Dioxide, M	Hot	A	A	A	Methyl Chloride, Dry	70°	A	A	A	Turpentine	70°	A	A	A
Carbonated Water	70°	A	A	A	Milk	Hot	A	A	A	Varnish	70°	A	A	A
Carbonated Bevera.	70°	A	A	A	Mine Water	70°	A	A	B	Vinegar	70°	A	A	B
Carbon Tetra., Dry	Boil	A	A	A	Natural Gas	70°	A	A	A	Water	70°	A	A	A
Carbon Tetra., Moist	Boil	C	C	B	Nitric Acid (contc)	Boil	A	A	C	Zinc Chloride	Boil	C	C	B
Chlorine, Dry	70°	C	B	A	Nitrogen	70°	A	A	A	Zinc Sulfate	Boil	B	A	B
Chlorine, Moist	70°	C	C	B	Oleic Acid	Boil	B	A	A					
Chlorinated Water	70°	C	C	A	Oxalic Acid (10%)	Boil	C	B	B					
Chloroform, Dry	70°	A	A	A	Oxygen	70°	A	A	A					

# Excellence in Manufacturing **UNAFLEX**<sup>®</sup>

ISO 2001: 2008 CERTIFIED



All merchandise sold by UNAFLEX<sup>®</sup> is subject to this Standard Warranty. Our products are warranted to be free from defects in material or workmanship. Our liability for breach of any and all warranties, expressed or implied, is limited to refunding our invoice price of the product, or at our option, to replacement of the product. If any product manufactured by UNAFLEX<sup>®</sup> is found by us to be defective either in material or workmanship, under proper usage and service, the invoice price will be refunded or at our option will be replaced free of charge including transportation charges, but not cost of installation. The refund of the invoice price or the replacement of the product is the maximum liability of the company. The sale of our products under any other warranty or guarantee, expressed or implied, is not authorized by the company.

Technical statements and engineering data in this catalog is the most accurate information available at the time of printing and are subject to change without notice. As UNAFLEX<sup>®</sup> does not supervise or control the use of our products, UNAFLEX<sup>®</sup> cannot be responsible for improper or misapplication of catalog data.