



**THERMAL
PRODUCTS** INC.
Engineered Solutions To
Industrial Applications

Adiabatic Cooling System

Adiabatic Condensers GVW/GVD

for HFCs, CO₂ and NH₃

Adiabatic Coolers GFD/GFW

for CO₂, water/glycol and other media

5 Tons – 400 Tons



With hydro **BLU**[™] technology



Güntner's Adiabatic Cooling System with hydroBLU™ Technology

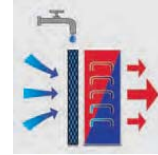

Wet When You Need It & Dry When You Don't

Efficient heat rejection is an economic success factor in any industry, particularly in air-conditioning, refrigeration, process cooling and data center applications. Water consumption is an ever increasing important criterion for choosing equipment in addition to the footprint, low investment, low operating costs and low noise emission. The growing scarcity of water and rising costs of water inspire us to offer eco-friendly products to help minimize natural resource consumption.

The Güntner Adiabatic Cooling System (ACS) with hydroBLU™ Technology is an advanced cooler or condenser utilizing the latest in heat transfer and controls technology. By using water only on peak days, the ACS cooler/condenser can often reduce water consumption to 20% of a conventional water cooled system and reduce peak energy demand versus a dry system. A system that is wet when you need it and dry when you don't, the ACS combines the reliability and ease of use of a dry cooler/condenser with system efficiencies associated with water cooled equipment.

The Adiabatic Cooling Delivery System utilizes a water management system and cooling pads to maximize adiabatic efficiency, minimize water consumption and safely manage water usage. In addition to the ease of operation, elimination of water treatment systems is typically applicable. The coils remain dry and effective water management helps to mitigate the proliferation of Legionella, pneumophila and associated illness.

The Adiabatic Cooling System offers an energy efficient solution that provides dramatic water savings relative to water cooled equipment by utilizing water only when ambient temperatures and system demand require it.

Adiabatic Dry Coolers

At peak ambient temperatures, the air entering the finned heat exchanger is pre-cooled by wetted cooling pads to a temperature approaching the wet bulb temperature, without aerosol formation and without applying water to the finned surface. The pre-cooling process maintains the required leaving fluid temperatures or condensing temperatures at peak ambient conditions. The adiabatic process significantly increases the thermal efficiency of the cooler or condenser with minimal water usage.

The increased thermal performance at peak ambient conditions lowers the total cost of ownership. The reduction in compressor energy usage permits higher COP's, with a significantly reduced footprint.

Cooling towers or evaporative condensers use water as the evaporative cooling source throughout the year. The adiabatic alternative only uses water at peak ambient conditions thereby significantly reducing water usage, water treatment, chemicals, sewage and the costs associated with each.

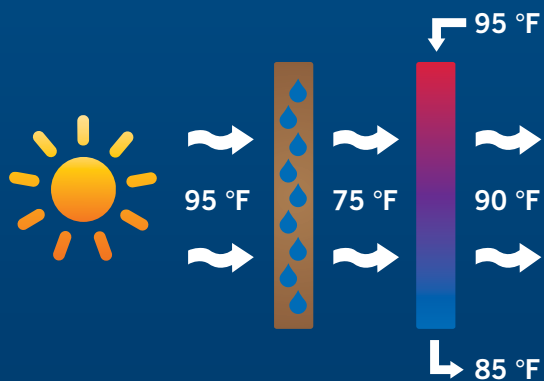

INDU
PRO
COOLING OF
COMPRESSORS

**INDUSTRIAL
PROCESSES**

**COOLING OF
IT EQUIPMENT**



**AIR CONDITIONING
HEAT REJECTION**

**REFRIGERANT
CONDENSING**

Tailored solutions for any application

Intelligent control of fan speed and wetting

- Water conserved by volume control
- Very low energy consumption using Electronically Commutated (EC) fans
- Very low water consumption because dry/wet switchover is set at a high level

Optimal adiabatic cooling delivery system

- Maximum adiabatic efficiency
- Plume-free
- No water circulation
- No aerosol output
- Automatic draining
- Dry cooling coil
- No spraying
- No water treatment required on typical systems

Multifunctional use of humidification pads

- Easily removed for dry operation
- Reliable adiabatic delivery system
- Protects coil from dirt and debris

Integrated, intelligent control

- Wired ready to use
- EC fans with the Güntner Motor Management (GMM) fan speed controller
- GMM step controller for fan cycling

Installation

- Easily rigged by crane thanks to easily accessible lifting lugs
- Quick and easy installation
- Optimal distribution of forces
- Rigid structure, resistant to deflection





Dry operation

- With no wetting of the unit, it operates like a conventional finned dry cooler or condenser
- Energy is dissipated to the ambient air via convection

Wet operation

- For high external temperatures and/or during higher cooling loads
- The fluid can be brought down below the ambient dry bulb temperature, even without directly wetting the heat exchangers
- Air is adiabatically cooled and then energy dissipated by convection

Minimal number of support feet

- High level of static stability
- Reduced installation costs

High power density

- V construction
- Optimized shipping dimensions

Ease of Use

- Maintenance free motors
- Easy access for cleaning
- Easily removable pads

Dry or wet operation

Adiabatic operating principle

Güntner's ACS coolers or condensers with hydroBLU™ Technology can be operated either wet or dry.

Both modes can provide excellent drycooler or condenser performance with a small footprint and low operating costs. The cooling limit, i.e. the theoretically best possible return temperature condensing pressure for the ACS is tied to the wet bulb temperature of the ambient air at the drycooler/condenser.

Our experts will configure the ACS specifically for your application and optimise it for its intended operation in your system. This is the only way of ideally dimensioning the drycoolers or condensers and minimising the operating costs of the complete system. Benefit from our experience!

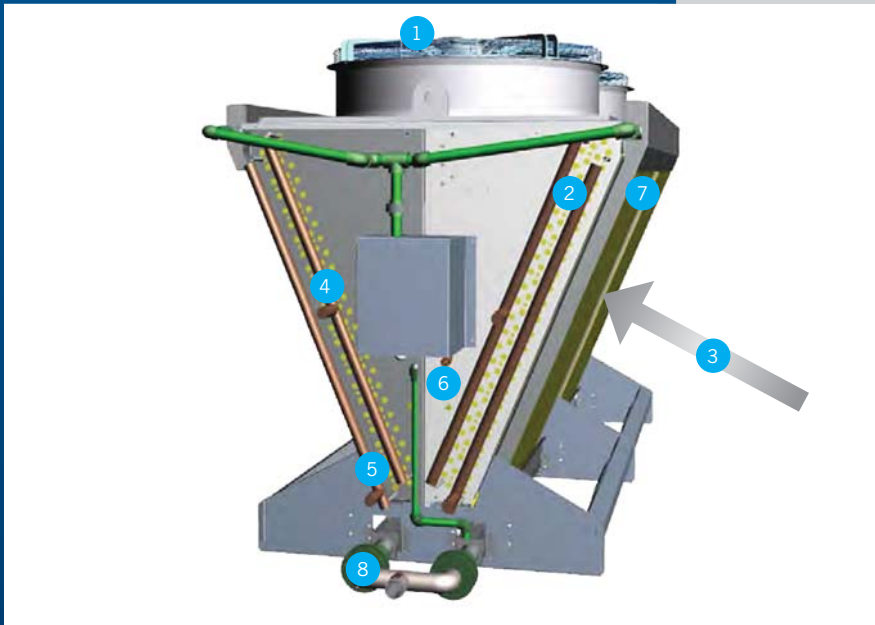

1. Fan unit
2. Dry, finned heat exchanger
3. Air flow
4. Fluid inlet
5. Fluid outlet
6. Water distribution inlet
7. Pre-cooling pad
8. Water outlet (drain)



Numerous possible combinations

- Various combinations of materials
- Configurable tube materials and geometries
- Various tubeside circuit options
- Various fin spacings possible

Maximum capacity range

- Capacity range from 5 - 400 tons
- Multitude of sizes to match application

Intelligent control saves operating costs

The efficient operation of adiabatic dry coolers depends very much on the intelligence and strategy of their functional control. The built-in control continually monitors all the significant parameters and automatically adapts the operating mode to the current system requirements. This guarantees a smooth and efficient unit operation and compliance with the predicted consumption values.

The GHM & GMM are designed as programmable logic controllers and allow for:

- Control the fluid outlet temperature
- Water distribution management
- Output of operational and fault signalling
- Communication with building management systems

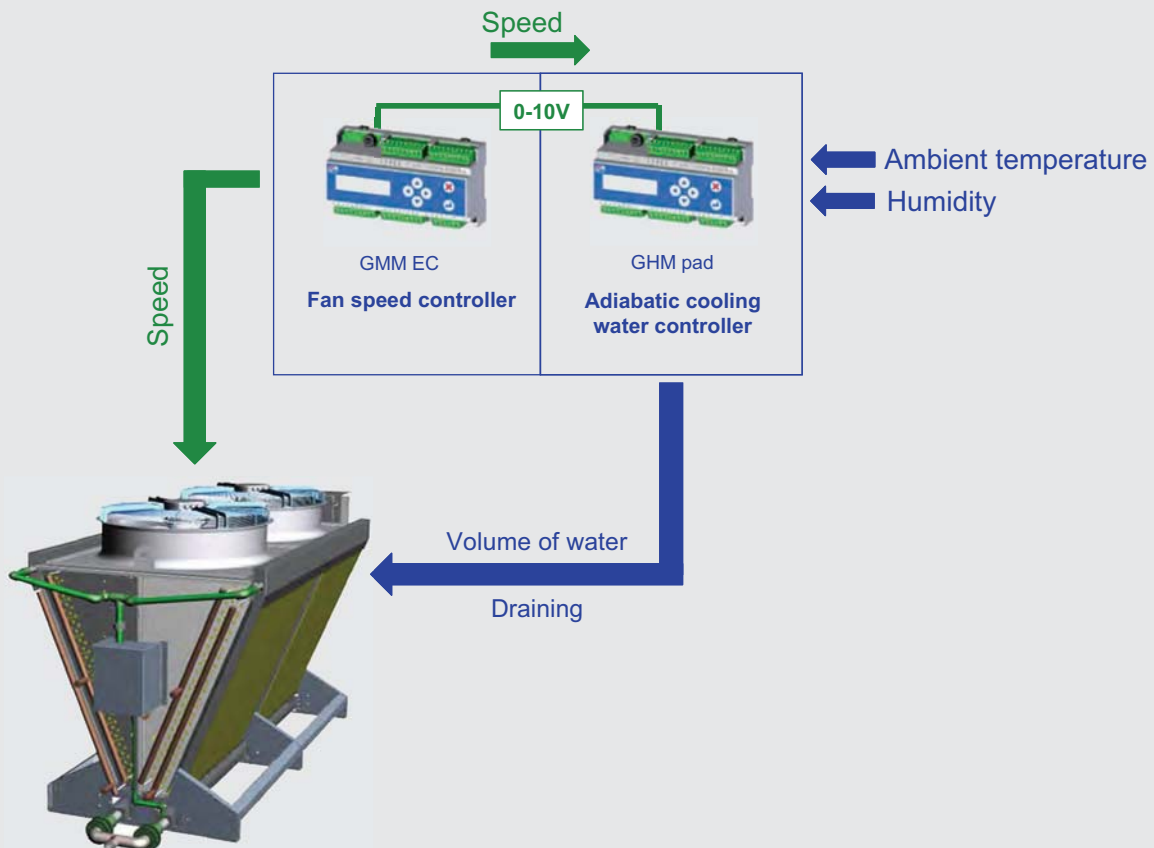

Customer benefits from our controller

- Optimized operation of individual units
- Parameters can easily be set for ideal use in a variety of applications
- Low operating costs
- Easily integrated into your building management system by conveying operational messages via contacts or a bus system
- Easy to install, supplied ready for connection
- Compact, adaptable and expandable



GMM – Energy-Efficient Intelligence for all Areas

The GMM system is available for AC or EC fans. A number of different technologies are used, but one feature is common to all management systems: They are equipped with a number of functions that serve to enhance energy efficiency.

	Energy efficiency	Controller	Investment	
AC fans Fan cycling is available for AC fans.	Fluid circuit ●●○○ Speed controller ●○○○	Precision ●●○○○ Noise ●●○○○	Investment costs ●●●●● Service life ●●●○○	GMM Step 
EC fans Maximum efficiency can be achieved with EC fans and the GMM EC.	Fluid circuit ●●●●● Speed controller ●●●●●	Precision ●●●●● Noise ●●●●●	Investment costs ●●○○○ Service life ●●●●●	GMM EC 

●○○○○ not so good
 ●●●●● very good



Water Conservation

Employing evaporative cooled equipment for heat rejection, while energy efficient and compact, requires a large consumption of water. Almost half of the water consumed by a typical grocery store in California is for evaporative cooling. The use of the ACS can reduce the water consumption by up to 80%. As our society struggles with drought and rapidly increasing cost of water and sewage, becoming conscientious stewards of our natural resources is of ever increasing importance.



Evaporative vs. Adiabatic analysis

Below is an example of Evaporative vs. Adiabatic analysis for Binghamton, NY, illustrating cost savings based on water and electrical consumption.

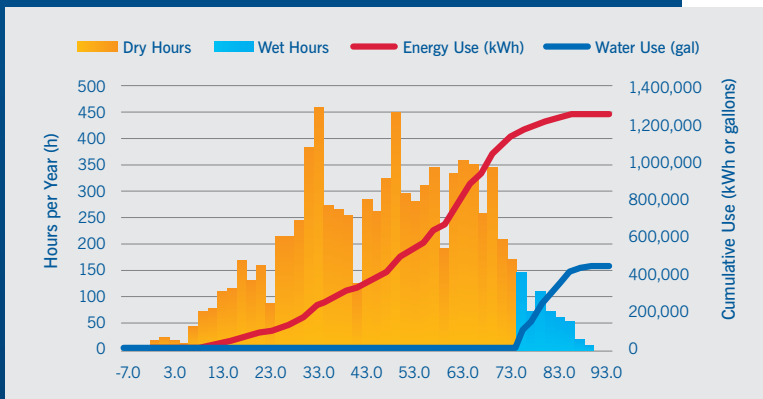

Annual Usage: Adiabatic in Water Priority Mode

400 Ton System
Annual water and energy cost:

Adiabatic: \$173,000
Evaporative: \$205,000

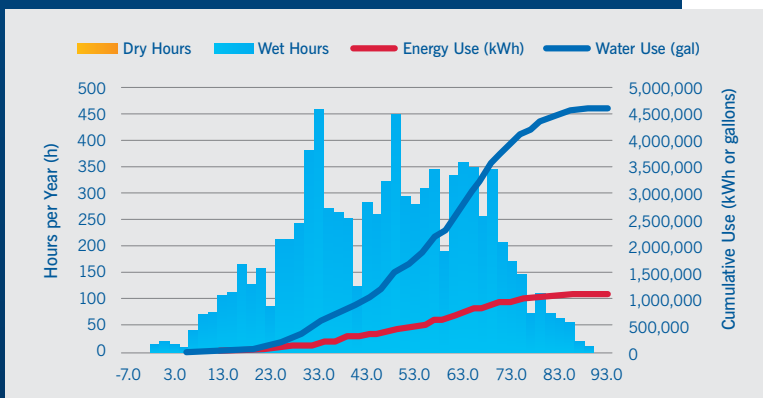

Annual Usage: Evaporative Cooler/Condenser

Power and Water Rates:

Electricity rate	\$0.10	\$/ kWh
Demand charge	\$11.00	\$/ kW / mo.
Water & sewage	\$8.00	\$/ kgal
Water treatment	\$4.00	\$/ kgal

Additional Options for your Adiabatic Cooling System



Epoxy coating

The service life of finned heat exchanger depends on localized conditions and concentrations of airborne elements. The service life of these heat exchangers can be significantly increased by using epoxy-coated fins. Epoxy resin is a thermosetting plastic which, once hardened, exhibits high strength and chemical resistance.



Coil options

Available with copper tubes or stainless steel tubes for use with CO₂, ammonia, halocarbons, hydrocarbons, glycols, brines or water.

Technical data for the ACS

Dimensions (aprox. range)	6'5" - 40' (L) x 4'4" - 8'6" (W) x 5'6" - 9'5" (H)
Weight empty	1,000 - 19,000 lbs
Heat exchanger design	Floating coil principle
Certification and marks	Quality standard ISO 9001 UL, ETL, CRN, and ASME U Stamp upon request
Transport/delivery	<ul style="list-style-type: none"> • Delivered assembled • Lifting lugs allow for simple unloading and rigging • Plastic wrapped to protect against inclement weather
Safety	<ul style="list-style-type: none"> • Operational reliability and leak prevention thanks to the floating coil principle. • Minimize the possibility of Legionella due to zero aerosol formation. • No stagnant water accumulation as water distribution system is one through.
Maintenance	Minimal maintenance, no water treatment requirements under typical circumstances, zero chemicals.
Installation	<ul style="list-style-type: none"> • Small footprint, high capacity • Integrated factory installed controls

Comparison

Comparison of the available cooling technologies according to a number of criteria:

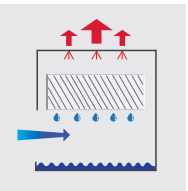
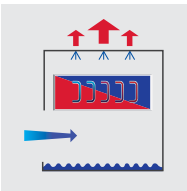
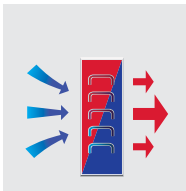
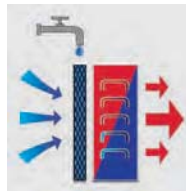
	 open cooling tower	 closed cooling tower	 dry cooler	 ACS dry cooler
Approach	+ + + +	+ + + ●	● ● ● ●	+ + + ●
No introduction of airborne impurities	+ ● ● ●	+ + + +	+ + + +	+ + + +
Low energy consumption	+ + + +	+ + + ●	+ + ● ●	+ + + ●
Low water consumption	+ ● ● ●	+ ● ● ●	+ + + +	+ + + ●
No aerosols or vapour plumes	+ ● ● ●	+ ● ● ●	+ + + +	+ + + ●
Low sound level	+ ● ● ●	+ ● ● ●	+ + ● ●	+ + + ●
Investment costs	+ + + +	+ + + ●	+ ● ● ●	+ + ● ●

+ ● ● ● not so good
+ + + + very good

Global Presence

Being your partner, we are committed to offering you global support. We speak the language of your market and understand your local requirements and regulations.



Guntner U.S. LLC
110 W. Hillcrest Blvd. Suite 105
Schaumburg, IL 60195
USA

Phone: + 1 847 781 0900
www.guntnerus.com

Members of Guntner Group

